

8353

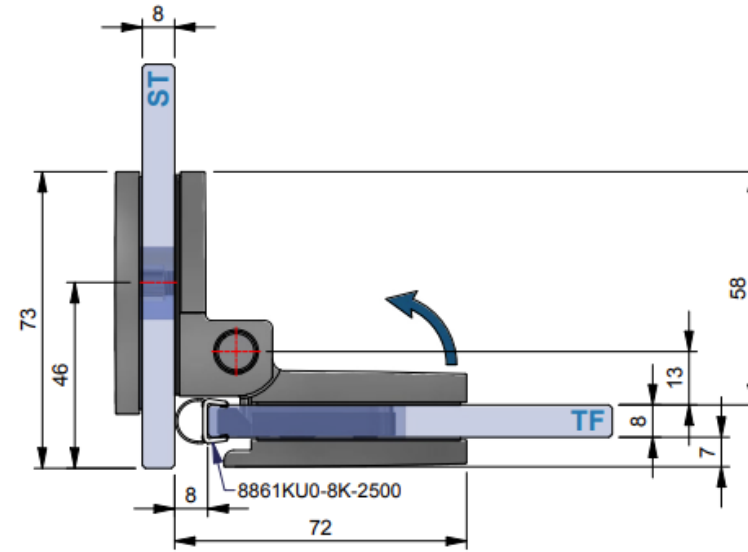

Opracovanie pri použití tesnenia 8861

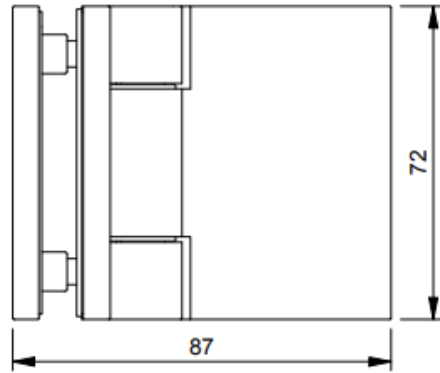